

Homework #2

Problem 1. (Rule of Pythagoras) Find the missing side of the triangle:

a)

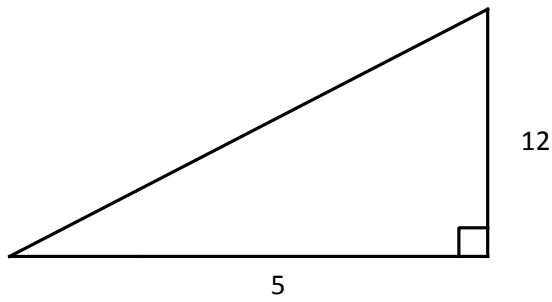

b)

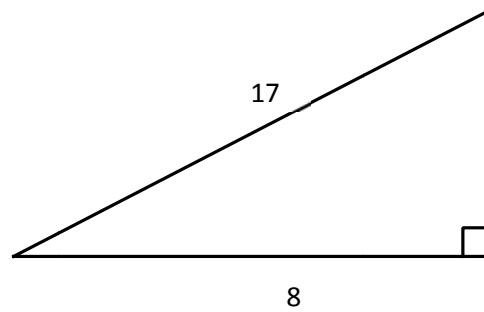

c)

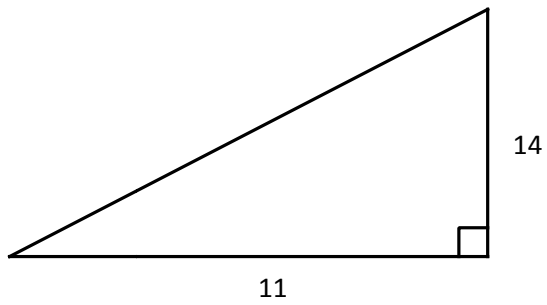

d)

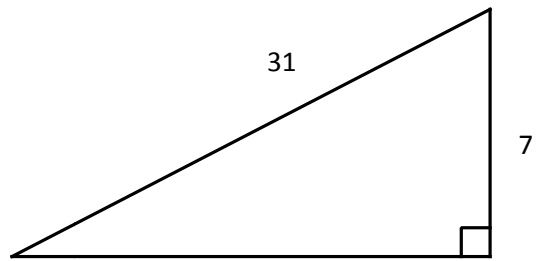

Problem 2. (Ratios) If the two triangles are **similar** (meaning proportional), find the unknown side.

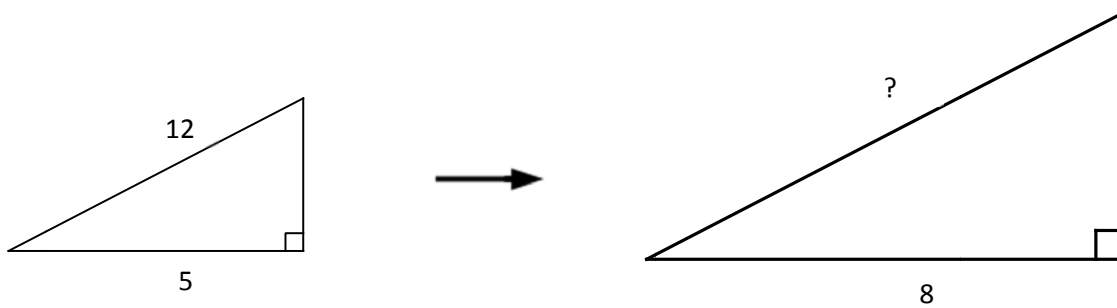

Problem 3. (Ratios) Find the unknown side given the appropriate ratio:

a)

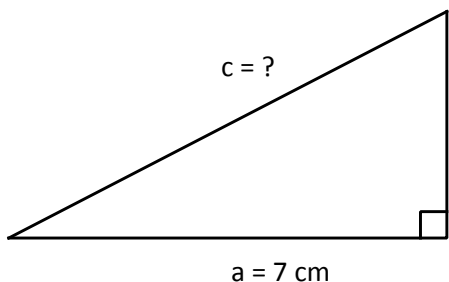

Ratio of a to c is 1 : 2.5
Working:

b)

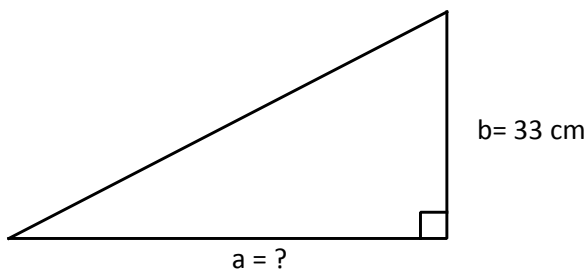

Ratio of b to a is 3 : 1
Working:

c)

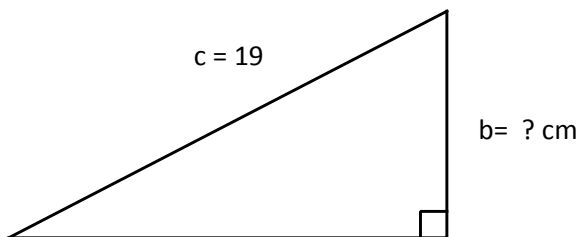

Ratio of b to c is 1 : 3.7
Working:

d)

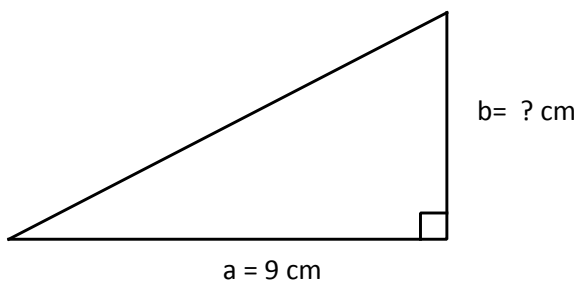

Ratio of a to b is 1.3 : 2.1
Working:

Problem 4. (Sin, Cos, Tan functions) Find the unknown side.

a)

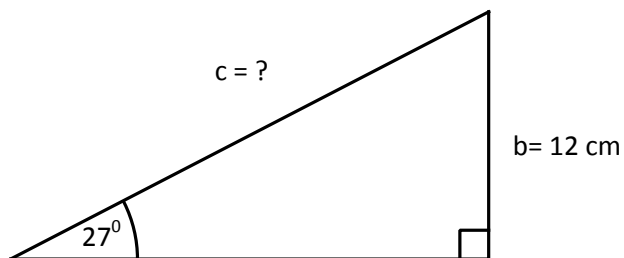

b)

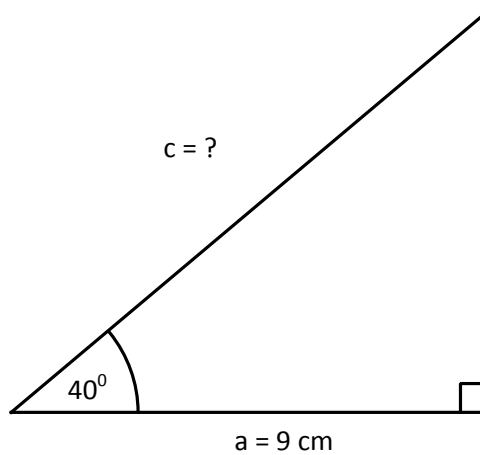

c)

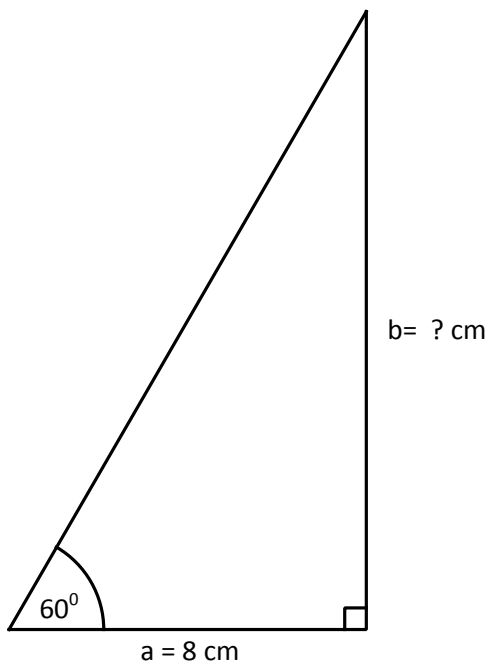

d)

